

# NV-1

DIN 24960



- (A, )
  - (U<sub>3</sub>)
  - (Q<sub>1</sub>, Q<sub>2</sub>)
  - Al<sub>2</sub>O<sub>3</sub> (V)
  - , FKM (V)
  - (P)
  - , EPDM (E)
  - , PTFE
- p = 16 (25)  
 - t = -50 ... 220°C  
 - v = 20 /

d <sub>1</sub>	d <sub>3</sub>	D <sub>4</sub>	D <sub>6</sub>	D <sub>7</sub>	D <sub>8</sub>	l <sub>3</sub>	l <sub>4</sub>	l <sub>ik</sub>
18	32	34	27	33	3	26	11.5	37.5
20	34	36	29	35	3	26	11.5	37.5
22	36	38	31	37	3	26	11.5	37.5
24	38	40	33	39	3	28.5	11.5	40
25	39	41	34	40	3	28.5	11.5	40
28	42	44	37	43	3	31	11.5	42.5
30	44	46	39	45	3	31	11.5	42.5
32	46	48	42	48	3	31	11.5	42.5
33	47	49	42	48	3	31	11.5	42.5
35	49	51	44	50	3	31	11.5	42.5
38	54	58	49	56	4	31	14	45
40	56	60	51	58	4	31	14	45
43	59	63	54	61	4	31	14	45
45	61	65	56	63	4	31	14	45
48	64	68	59	66	4	31	14	45
50	66	70	62	70	4	32.5	15	47.5
53	69	73	65	73	4	32.5	15	47.5
55	71	75	67	75	4	32.5	15	47.5
58	78	83	70	78	4	37.5	15	52.5
60	80	85	72	80	4	37.5	15	52.5
63	83	88	75	83	4	37.5	15	52.5
65	85	90	77	85	4	37.5	15	52.5
68	88	93	81	90	4	37.5	15	52.5
70	90	95	83	92	4	43	17	60
75	99	104	88	97	4	43	17	60
80	104	109	95	105	4	43	17	60
85	109	114	100	110	4	43	17	60
90	114	119	105	115	4	48	17	65
95	119	124	110	120	4	48	17	65
100	124	129	115	125	4	48	17	65

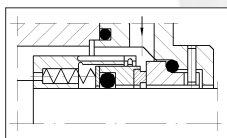
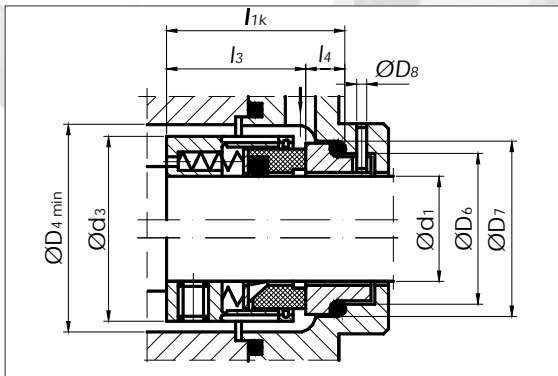

NV-1.1

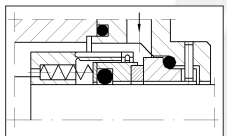

NV-1.2

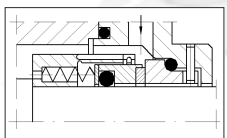

NV-1.3

NV-1/SC/

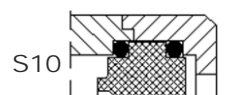
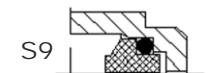
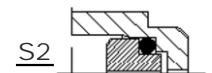
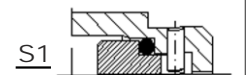

DIN 24960 (EN12756)